



User Instructions  
**Motorized Villa Pergola**

SIZE:600X400 CM

1-844-776-2266  
WWW.PROCAMDISTRIBUTION.CA  
INFO@PROCAMDISTRIBUTION.CA



# CONTENT

TOOLS AND MAN FORCE.....	3
PARTS LIST.....	4
PRODUCT DESCRIPTION.....	6
IMPORTANT SAFETY INSTRUCTIONS .....	7
MOUNTING AND USAGE.....	8-17
MOTOR SETUP.....	18
DISMOUNTING .....	19
STORAGE .....	19
DISPOSAL.....	19



**ATTENTION:**  
READ THIS INSTRUCTION MANUAL CAREFULLY AND COMPLETELY BEFORE MOUNTING AND USAGE. KEEP THIS MANUAL FOR FUTURE REFERENCE.

Dear Customer,

We, Procam distribution thank you for buying our Villa Pergola. To enjoy this product for a long time and for your own and other people's safety, please follow the assembly's instructions.

Before you start the assembly process and then using the Pergola, we suggest you get familiar with this product. Make sure all parts are listed up in the part lists below are delivered and intact. If you find any missing or damaged parts, please do not install the pergola and contact us immediately. Do not start the assembly process if parts are missing or defective.

## TOOLS AND MAN FORCE

RECOMMENDED: 3 PEOPLE

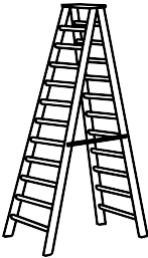
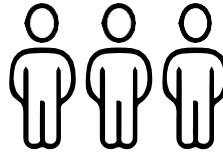

LADDER x2  
>1.5m

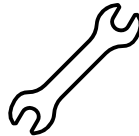

M10/13 OPEN WRENCH  
SUPPLIED



RUBBER MALLET



MEASURING TAPE



5MM HEXAGON WRENCH  
SUPPLIED



PENCIL

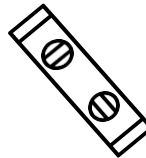

SPIRIT LEVEL

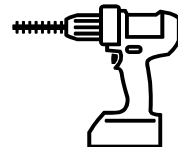













ELECTRIC DRILL



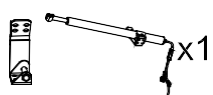













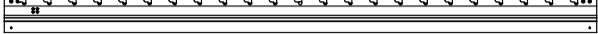

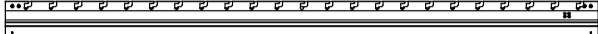

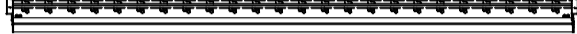













**ATTENTION:**  
PLEASE CHECK ALL PARTS AGAINST THE PARTS LISTED BEFORE STARTING THE PERGOLA'S CONSTRUCTION.

## PARTS LIST

①	 x 12	⑦	 x128	⑬	 x 2
②	 x 4	⑧	 x128	⑭	 x 2
③	 x 6	⑨	 x1		
④	 x 4	⑩	 x1		
⑤	 x 2	⑪	 x24		
⑥	 x140	⑫	 x4		

### HARDWARE AND OTHER PARTS:

- |                           |                              |
|---------------------------|------------------------------|
| ① M8*20 countersunk screw | ⑧ Locking nut                |
| ② Screw for motor fixing  | ⑩ Motor 2 with motor bracket |
| ③ Base plate              | ⑪ M8*100 expansion bolt      |
| ④ Upright cover           | ⑫ Gutter connector           |
| ⑤ M10 screw cap           | ⑬ 50 to 40 connector         |
| ⑥ M8*20 Hexagon bolt      | ⑭ Remotes                    |
| ⑦ Plastic Spacer          |                              |

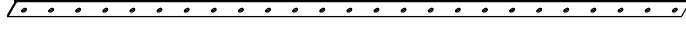
A-1			x 2
A-4			x 2
A-2			x 1
A-3			x 1
A-5			x 1
B-1			x 4
B-2			x 2
B-3			x 2
C-1			x 1
C-2			x 1
C-3			x 1
C-4			x 1
C-5			x 2
D-1			x 60
D-2			x 2
D-3			x 2
E			x 4

**ALUMINUM PROFILE PARTS LIST:**

(A-1) Beam/ (A-4) Beam

(A-2) Beam with left motor direction & slots

(A-3) Beam with right motor direction & slot

(A-5) Middle beam

(B-1) Gutter

(B-2) Gutter

(B-3) Middle Gutter

(C-1) Post + post connector

(C-2) Post + post connector

(C-3) Post + post connector

(C-4) Post + post connector

(C-5) Middle Post + post connector

(D-1) Common louver

(D-2) Centre louver

(D-3) Driving louver

(E) Control rod

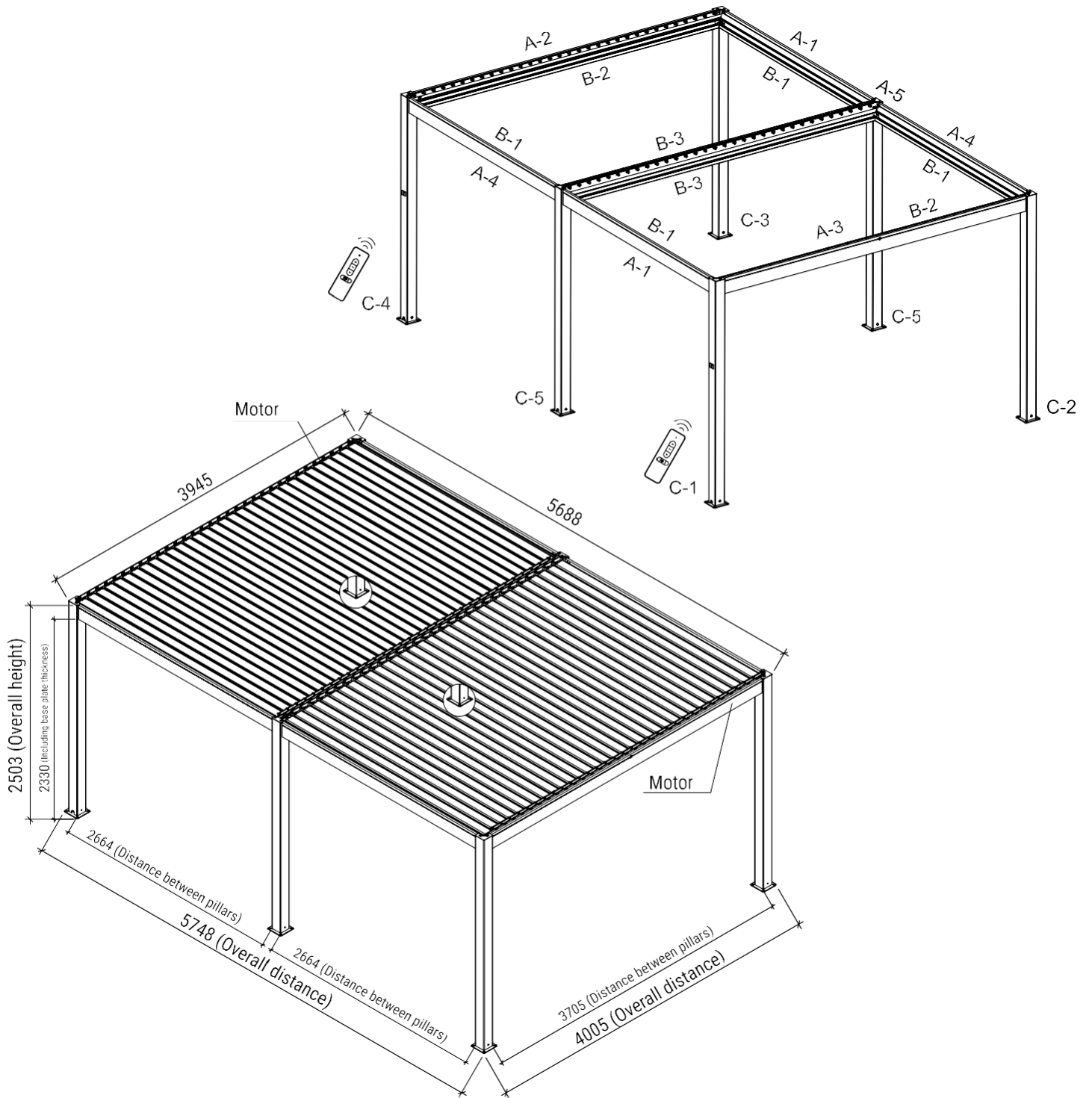

## PRODUCT DESCRIPTION

Make the most of your outdoor living area with your pergola. Relax and enjoy the outdoors while being protected from sun. The coated aluminum frame pergola is perfect for shading your garden, deck, courtyard and swimming pool.

## IMPORTANT SAFETY INSTRUCTIONS

**WARNING: FOR YOUR AND OTHER PEOPLE'S SAFETY, IT IS IMPORTANT TO FOLLOW THE INSTRUCTIONS BELLOW AND OBEY WARNINGS.**

### SYMBOL EXPLANATION



This warning triangle calls attention to hazards that can lead to death or to severe injuries or to the primordial elements for the functioning of the Pergola.



This sign identifies important notes.

### SAFETY INSTRUCTIONS



**TO INSTALL THIS PERGOLA TECHNICAL KNOWLEDGE IS NECESSARY.** Do not mount this pergola yourself and contact a professional workman for help if:

- you are unsure if the pergola can be mounted on the place you chose for installation.
- you do not understand the instruction manual or parts of it.
- you do not have necessary tools available.
- you do not have necessary technical knowledge



**A MINIMUM OF THREE HEALTHY ADULTS ARE REQUIRED TO MOVE AND INSTALL THE PERGOLA.** The product is big and heavy. Do not try to install the pergola alone. The pergola can cause serious injuries and damages if it falls. Contact an authorized assembler for help.



**DO NOT INSTALL THE PERGOLA WHEN YOU FIND DAMAGED OR MISSING PARTS.** Contact your dealer.



**KEEP CHILDREN AND PETS OUT OF THE WORKING AREA DURING ASSEMBLY AND ADJUSTMENTS.**



**THIS PRODUCT AND ITS FIXING PARTS ARE ONLY SUITABLE FOR INSTALLATION ON A RAW CEMENT WALL OR STABLE BRICKWORK. CONSULT A PROFESSIONAL IF YOUR WALL/BRICKWORK SHOWS CRACKS.**



**NOBODY IS ALLOWED TO CHANGE THE PRODUCTS' DESIGN AND STRUCTURE** without the permission of the manufacturer or it authorized deputy.



Make sure your hands are clean at the time of the assembly to avoid soiling the frame.



**NOBODY IS ALLOWED TO CLIMB ONTO THE PERGOLA. HANGING ANYTHING ON THE PERGOLA IS PROHIBITED.**

The sheeting is used to protect the paint, it must be removed afterwards.

This structure is non-permanent, the warranty does not cover damage incurred under extreme weather conditions including heavy rain, high winds or if exposed to high heat from heaters or BBQs.

Safety precautions should always be followed when assembling and using this product to reduce the risk of personal injury and damage to equipment. Please read all instructions before assembly and use. Never leave children unattended around/under this pergola. Do not attempt to assemble or use the pergola in moderate or heavy wind conditions. **ALWAYS KEEP THE PERGOLA LOUVER OPEN** and secure it during heavy winds or extreme weather conditions to avoid damage to the pergola or personal injury.











# MOUNTING AND USAGE

## STEP 1

Attach base plate ③ x6 to the bottom of posts (C-1 x1, C-2 x1, C-3 x1, C-4 x1, C-5 x2), use bolts ① x12 to attach with hex key or electric drill

C-1 & C-3, C-2 & C-4, C-5 & C-5 posts should be installed diagonally as below

Please make sure all posts are on the same horizontal plane.



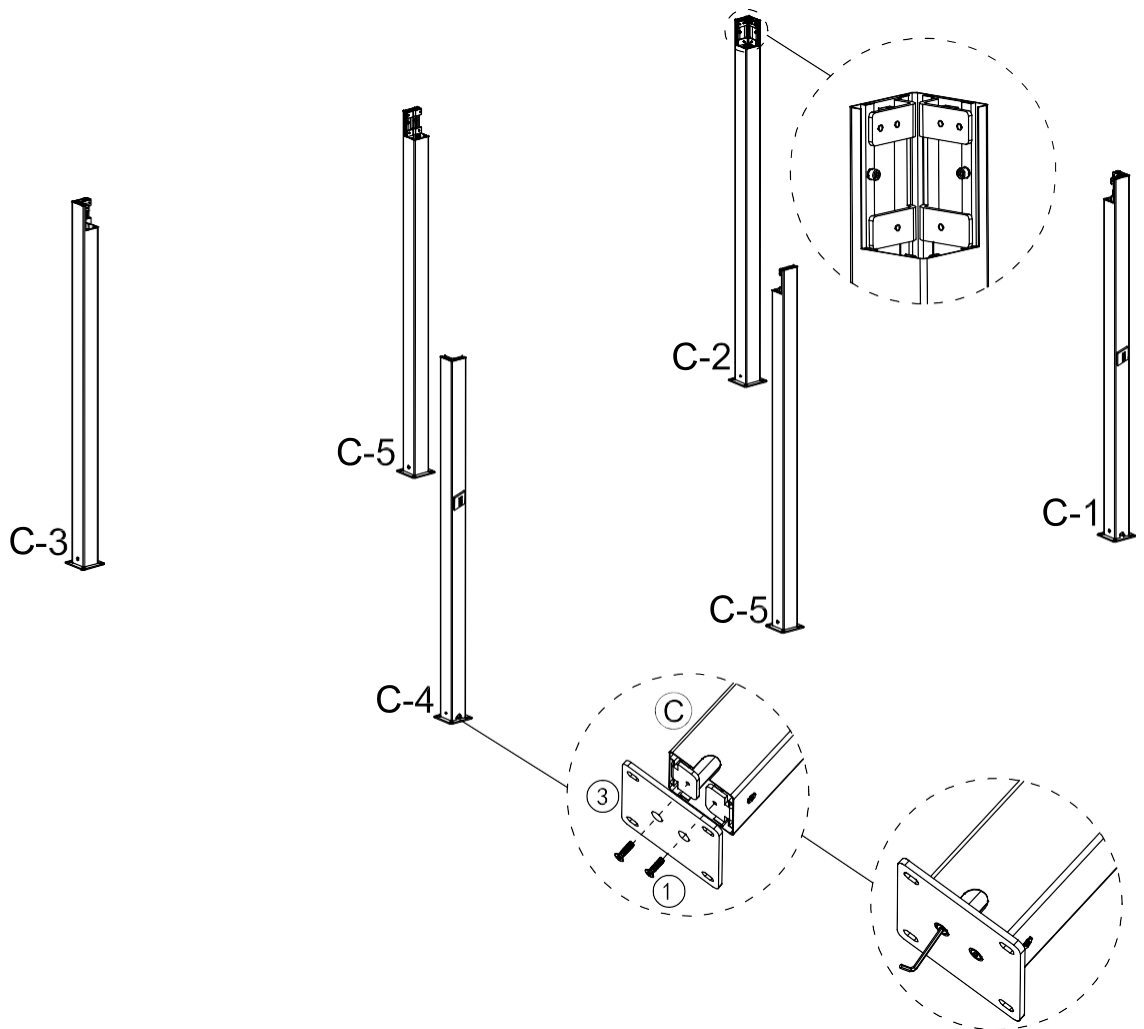



① x 12	
③ x 6	
C-1 x 1	
C-2 x 1	
C-3 x 1	
C-4 x 1	
C-5 x 2	



## MOUNTING AND USAGE

### STEP 2

Attach beam A-1 x2 beam, A-4 x2, beam A-2 x1, beam A-3 x1, beam A-5 x1, use bolts ⑥ x32 to fasten.

⑥ x 32	
A-1 x 2	
A-4 x 2	
A-2 x 1	
A-3 x 1	
A-5 x 1	

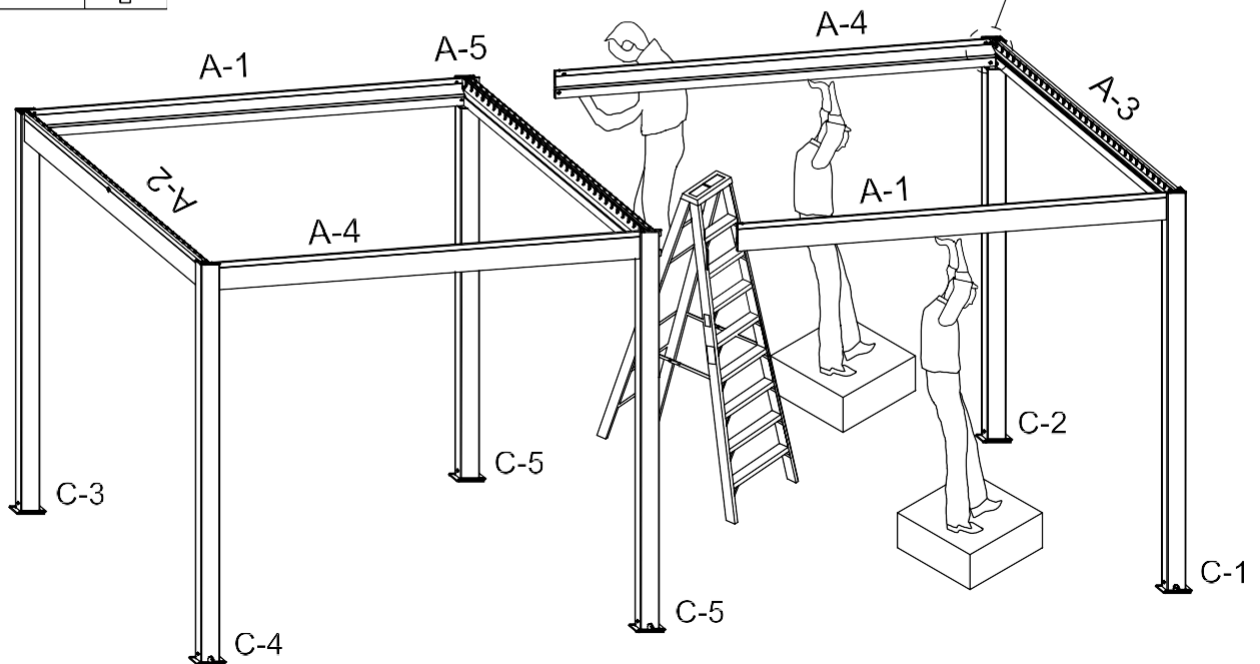
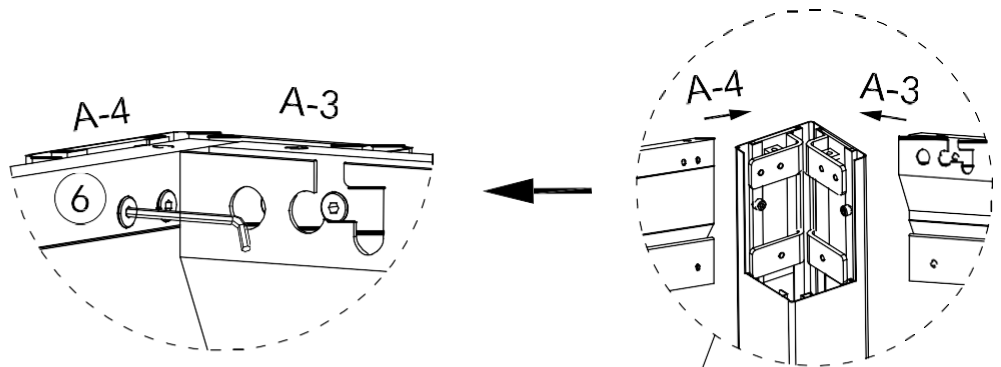

## MOUNTING AND USAGE

### STEP 3

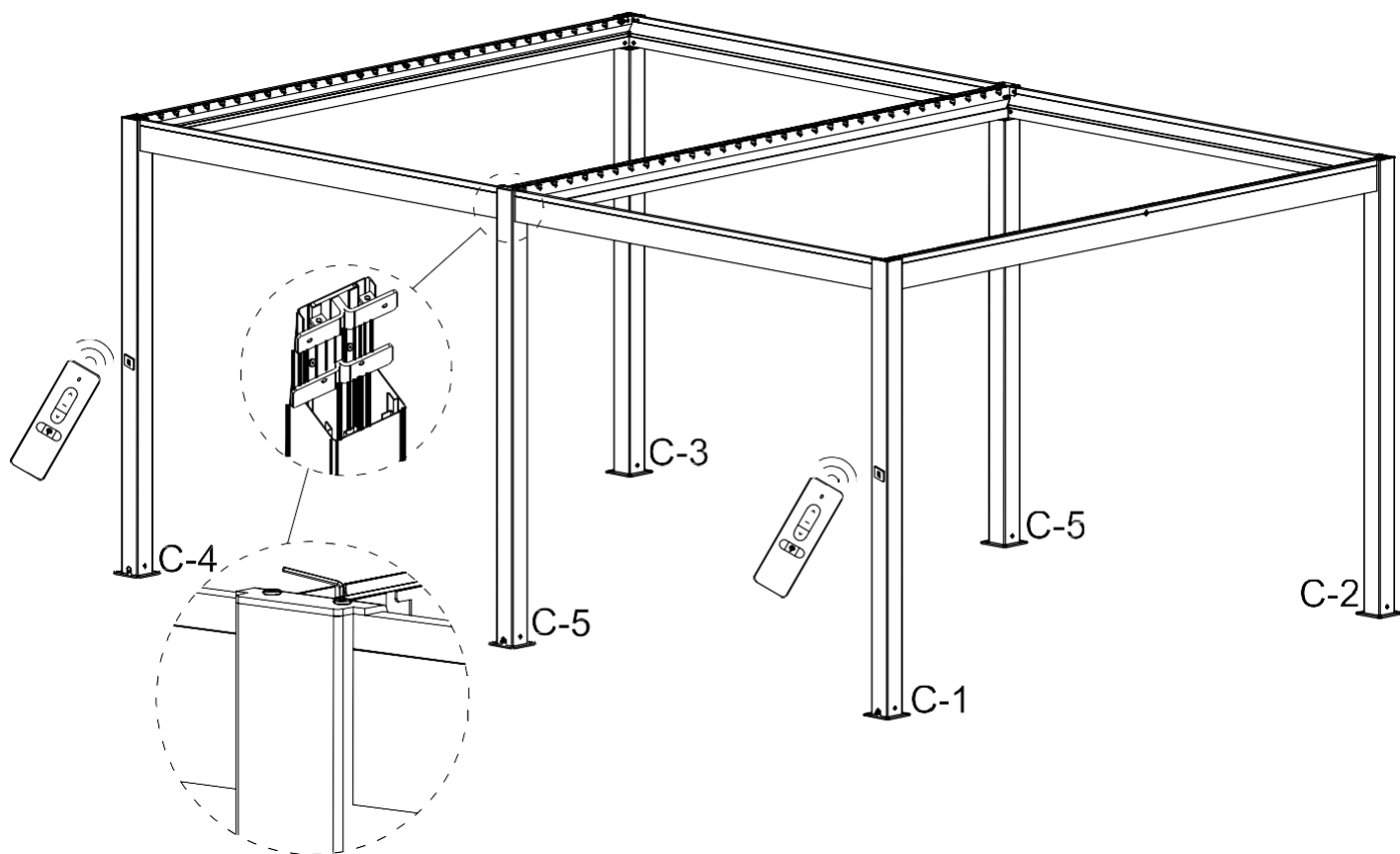
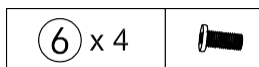

Use bolts ⑥ x 4 to fasten beam A-1 & beam A-4.



## MOUNTING AND USAGE

### STEP 4

Attach upright cover ④ x4, use bolts ⑥ x8 to fasten.

⑥ x 8	
④ x 4	

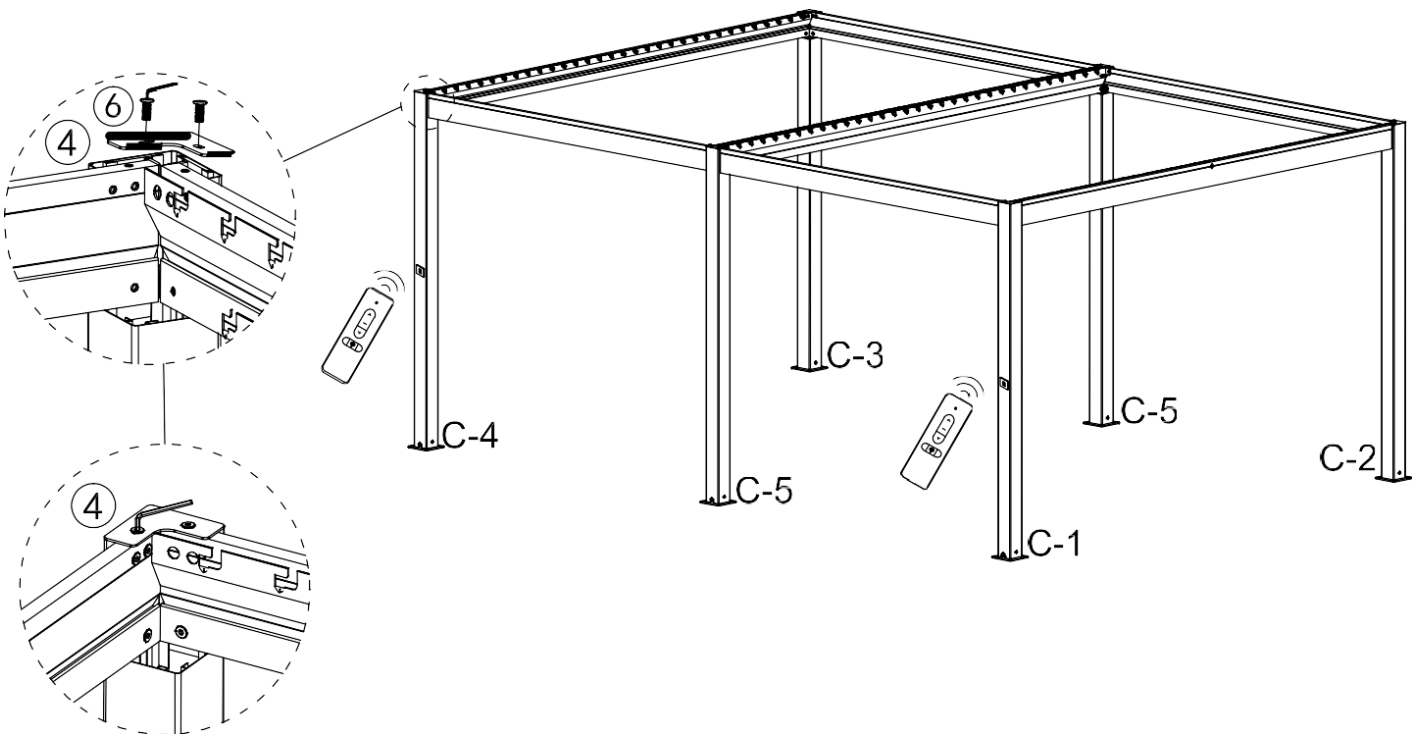

## MOUNTING AND USAGE

### STEP 5

Attach all eight gutters B-1 x4, B-2 x2, B-3 x2 by hooking inside the A-1, A-2, A-3 beams

Draw a caulking joint between the beams and the gutters in order to improve the impermeability.

B-1 x 4	
B-2 x 2	
B-3 x 2	

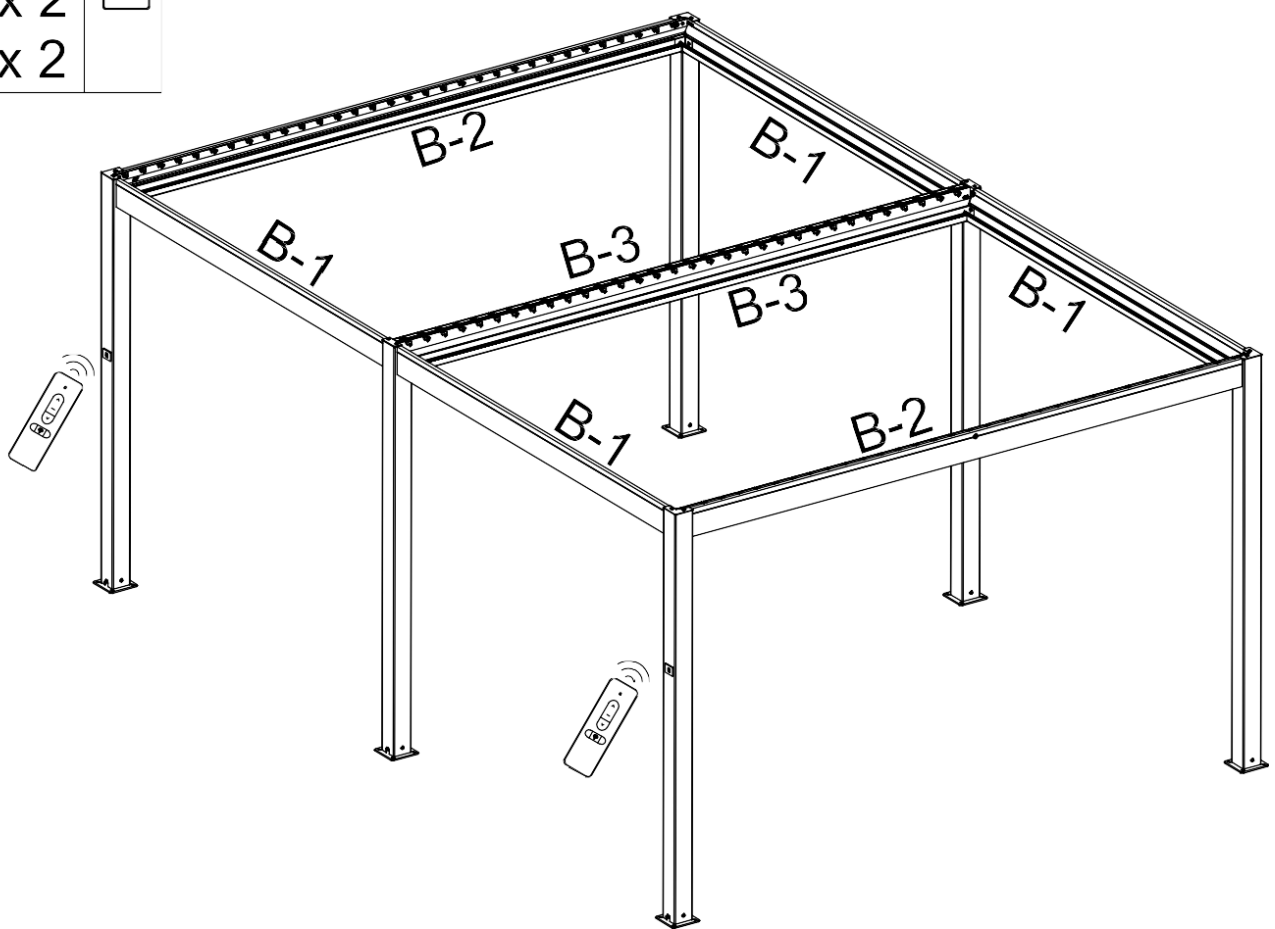

## MOUNTING AND USAGE

### STEP 6

Located holes in center of beams(A-2, A-3, A-5)

Place centre louver D-2 into the hole on slot beam A-2, A-3, A-5, lining up with the holes for 600x400cm size.

Using M10 nut ⑤ x2, secure the louver in place

Place Driving louver D-3 in line with 6th slot (check attached direction on the beam A-2, A-3, A-5)

Fit all common louvers D1 into the remaining slots in the beams

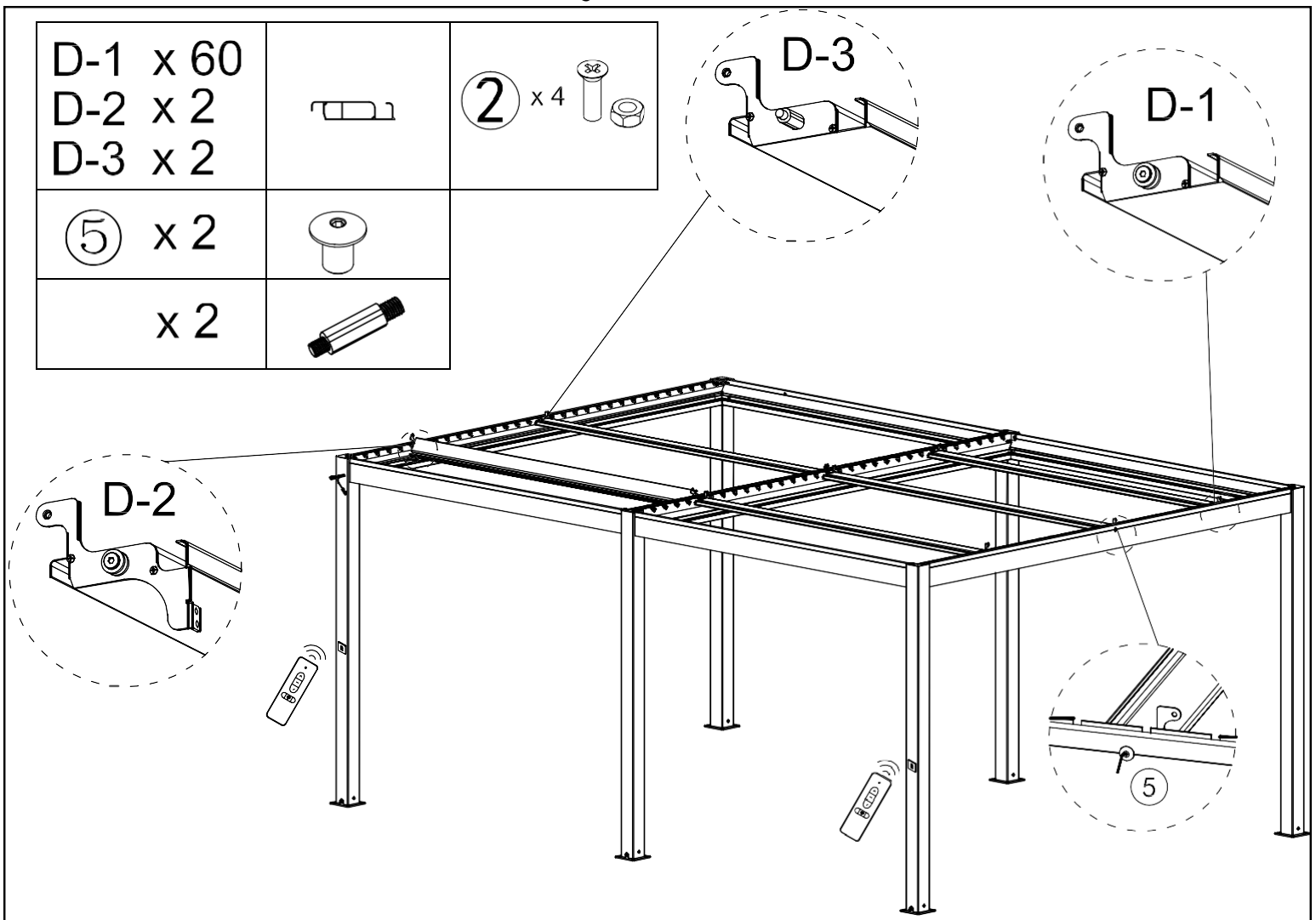

# MOUNTING AND USAGE

## STEP 7

Fasten motor ⑨ x 1 + ⑩ x 1 as shown below.

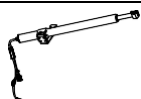
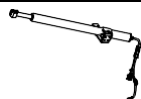
⑨ x 1	
⑩ x 1	

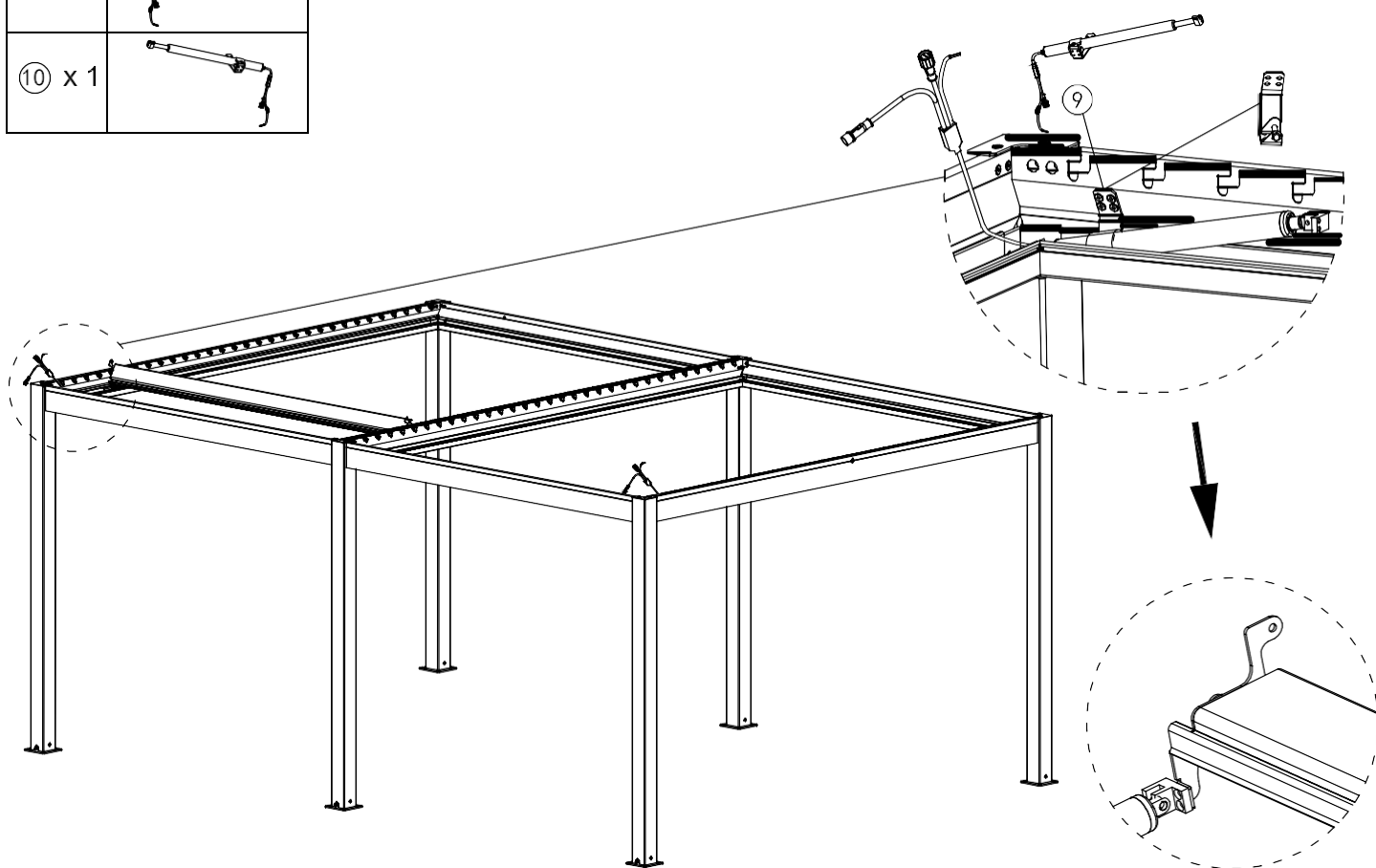



## MOUNTING AND USAGE

### STEP 8

Fasten ⑫ x4 gutter connector and ⑬ x2 (50 to 40 connector).

Connect the female and male plugs for the LED lighting (DC24V to DC24V) and motor (DC24V to DC24V) and plug the power cable into local socket.

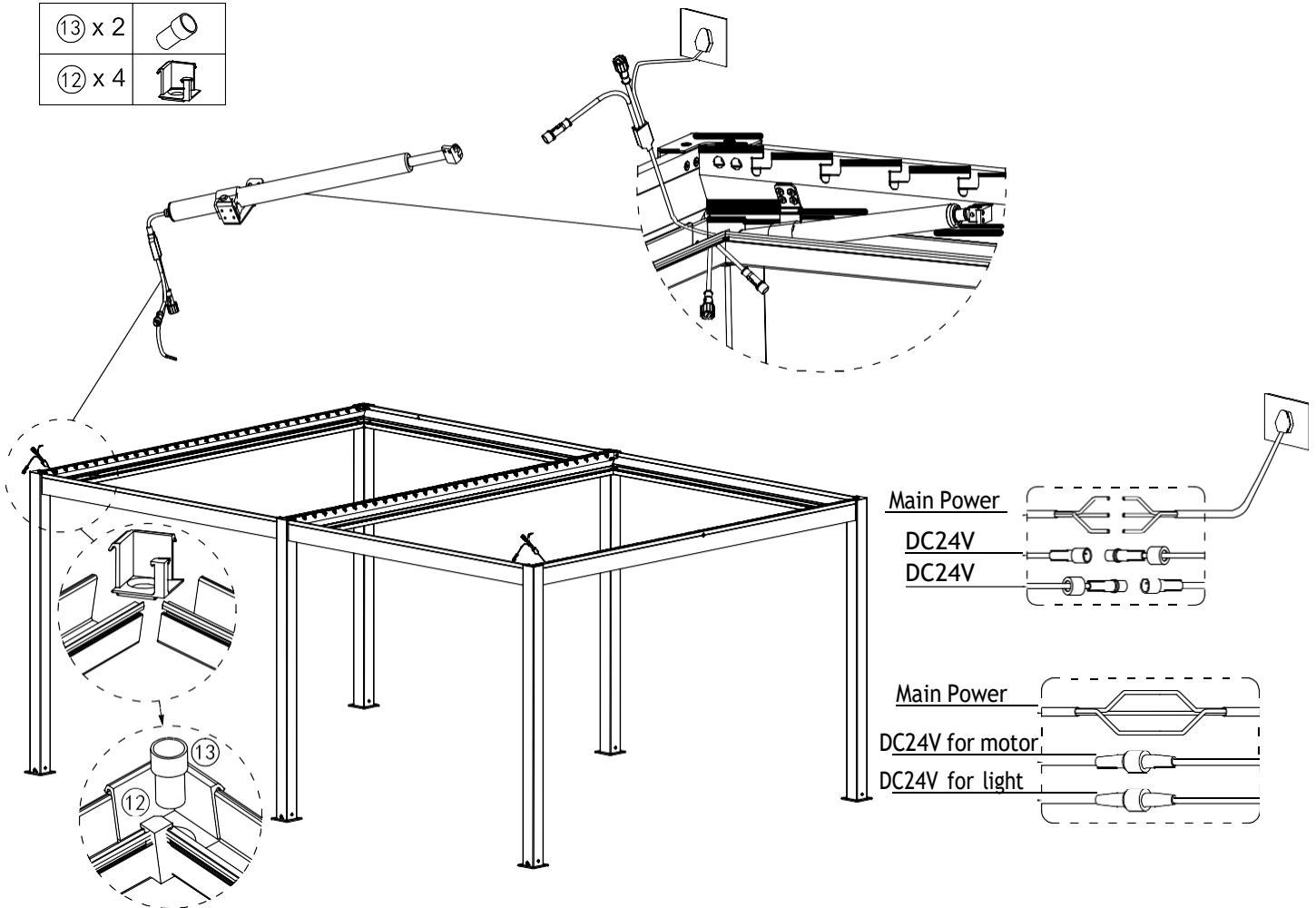

## MOUNTING AND USAGE

### STEP 9





Fix (E) x4 (flat L-shaped aluminum profile).

One for each other of the slats is required.

Use bolt (D) x128, plastic spacer (7) x128 and nut (8) x128 to tighten for 600x400cm size.

Secure the louvers at each end.

**NOTE: Do not over tighten.** Over tightening will prevent louvers from moving.

⑥ x 128	⑦ x 128	⑧ x 128	E x 4
			

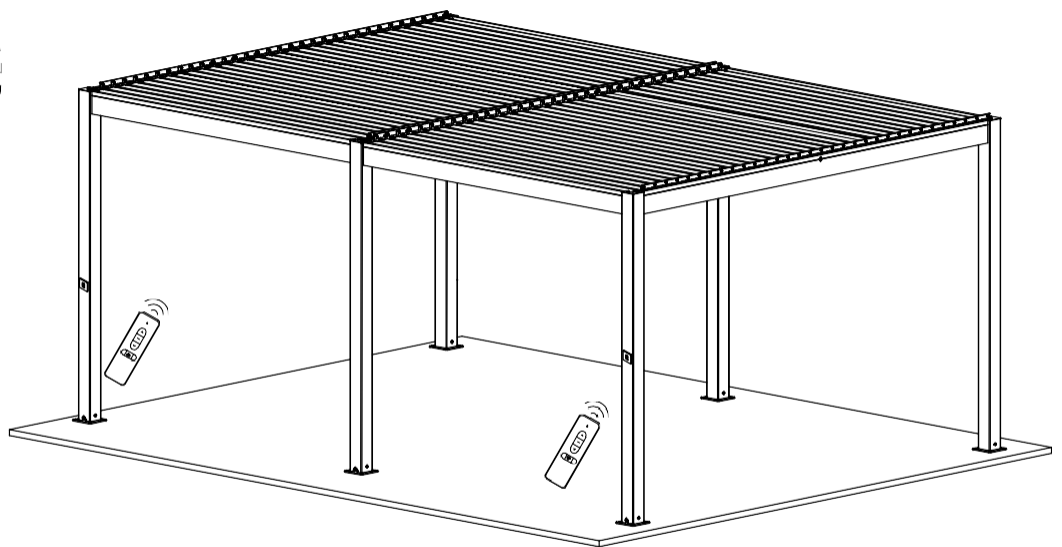
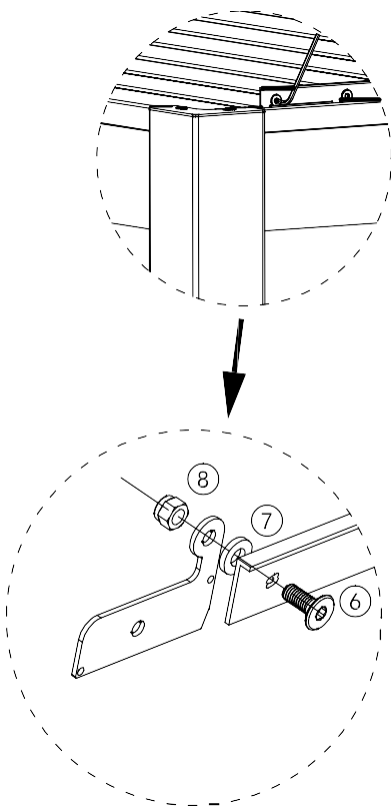

## MOUNTING AND USAGE

### STEP 10

Mark holes for expansion bolt ⑪ x4 on each post.

NOTE: the drill size should be 12 mm.

Insert the bolts. Use a hammer drill if necessary. Place the posts over the bolts. Tighten the nuts.

Once installed, make sure any remaining plastic is removed and silicone is used along all corners and gutters to waterproof.

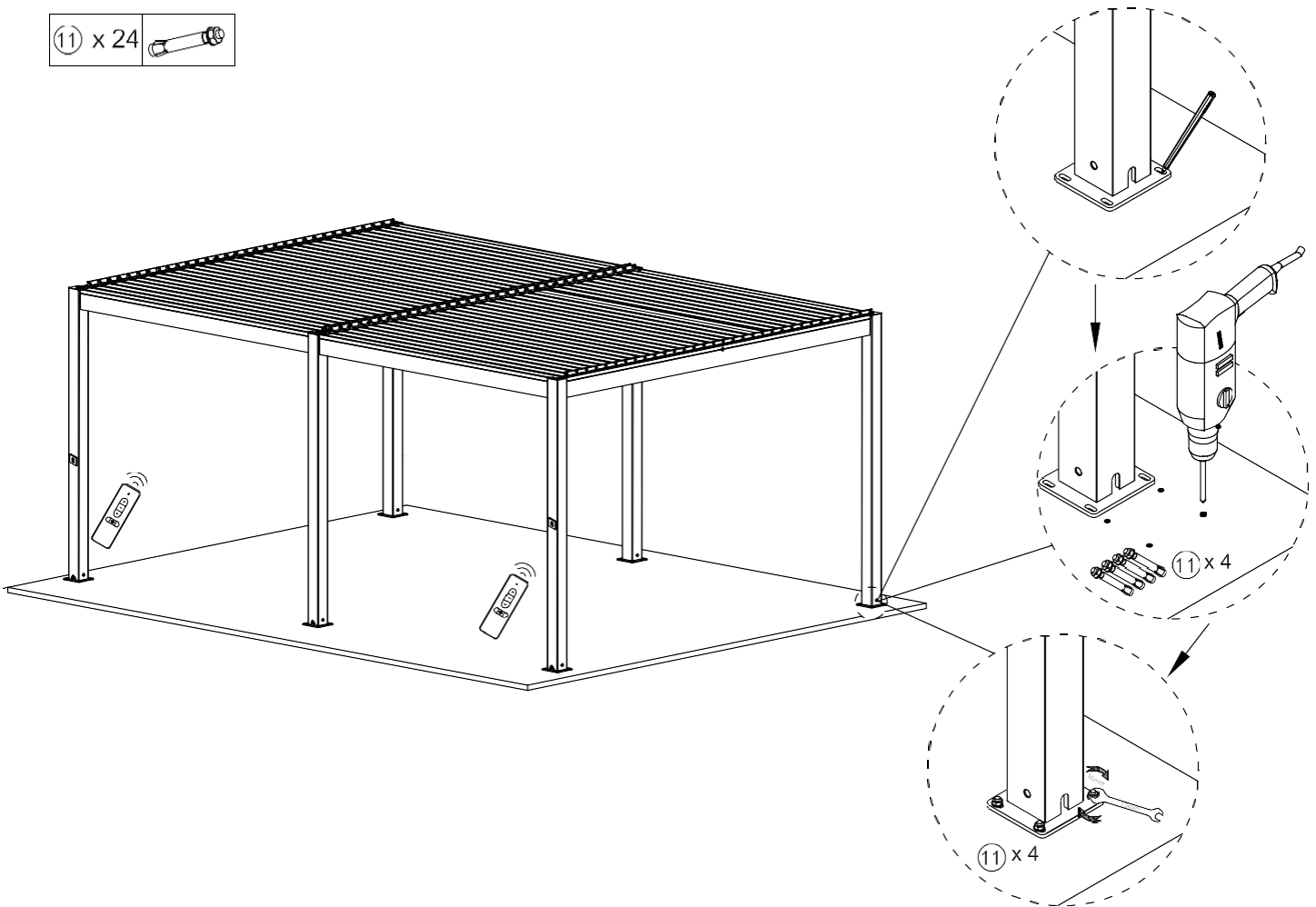
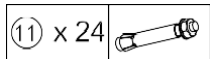

## MOTOR SETUP

### 86 OPERATION INSTRUCTIONS FOR DC CONTROLLER WITH LAMP CONTROL

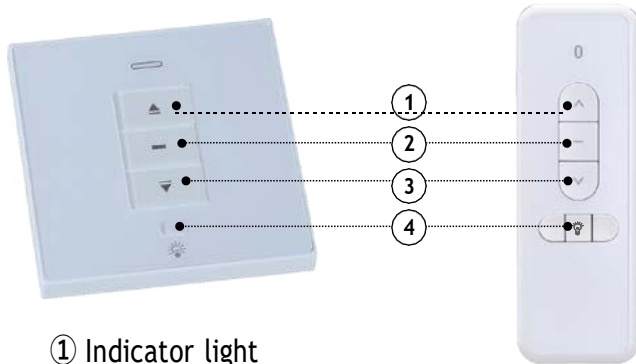

- ① Indicator light
- ② Closing button
- ③ Stop button
- ④ Opening button

### CHARACTERISTICS

- Exquisite and unique appearance design;
- 86\*86 national installation standards;
- Using impulse current relay;
- Adopting precision SMT process, surface moisture-proof treatment;
- Parts of electrical apparatus meet the requirements of fire safety standards for electrical standards;
- Power supply safety protection, the power output time is 5 minutes;
- Can be cooperated with all kinds of launchers and tubular motors.

### PARAMETERS

Product model	ZC31-03-2AD
Input voltage	AC100V-240V
Load power	Lamp≤500W–Motor≤48W
Receiving/ transmitting frequency	433.92MHz
working temperature	-30°C~+65°C
Receiving sensitivity	-110dBm
Number of transmitters allowed	≤8 pcs
Operation mode	Remote / manual control

### WIRING

lamp controlled DC receiver (ZC31-03-2AD)

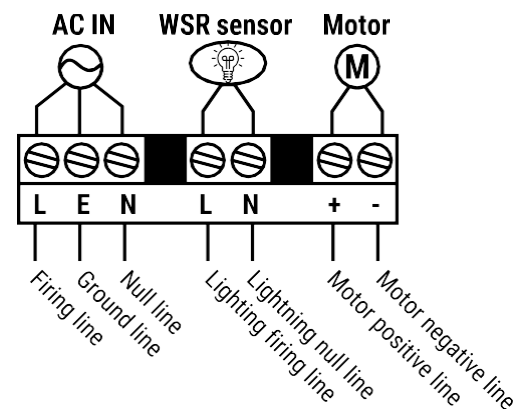

### INSTALLATION NOTES

- The main power source must be cut off before installation.
- Transmission distance≤80 meters.
- Please use soft wire and soft cable.
- Avoid electrostatic interference, otherwise it will damage the components.
- Ensure that cable carriers are not affected by longitudinal forces after installation.
- Maintain a distance of:
  - 1.5 meters between receiver and ground.
  - 0.3 meters between receiver and ceiling.
  - 1.5 meters between receiver and motor.

### ACTIVATING LOUVERS AND LIGHTS

#### INITIAL PROGRAMMING

- Turn on electricity
- Press on the **lamp key** for 5 seconds to turn on.
- Press on the **lamp key** for 15 seconds to turn off.



**ATTENTION:**  
ENSURE LOUVERS ARE OPEN DURING PERIODS OF MILD TO STRONG WINDS.

## DISMOUNTING

IF YOU WANT TO DISASSEMBLE THE PERGOLA, PLEASE FOLLOW THE FOLLOWING PROCESS.



**ATTENTION!**  
SAFETY HINTS AND INSTRUCTIONS MUST BE FOLLOWED FOR DISMOUNTING AS WELL.  
AT LEAST **TWO** PEOPLE ARE NEEDED FOR THIS STEP.

Keep the Pergola louvers open before you begin with dismantling. Bind the Louvers of the Pergola together to avoid unintended unfolding. This might cause damage and injury. You can use the protection band that was fixed on the Pergola when purchasing it.

Follow the mounting instructions in reversed order to dismantle the Pergola.

Make sure the drilling holes in the wall will be sealed by a professional.

## STORAGE

If you don't want to use the Pergola for a longer time, it is recommended to take the Pergola out of the brackets and store it.

- Make sure the frame is dry completely before storing.
- Store the Pergola at a dry, safe and unreachable place for children.

## DISPOSAL

Do not dispose this Pergola with other household wastes. To prevent possible harm to the environment or human health from uncontrolled waste disposal, recycle it responsibly to promote the sustainable reuse of material resources. To return your used device, please use the return and collection systems or contact the retailer where the product was purchased. We can take this product for environmental safe recycling. Dispose packing materials according to local guidelines.

1-844-776-2266  
WWW.PROCAMDISTRIBUTION.CA  
INFO@PROCAMDISTRIBUTION.CA

